

Operating instructions and Spare parts list

Manual equipment OptiFlex Pro B

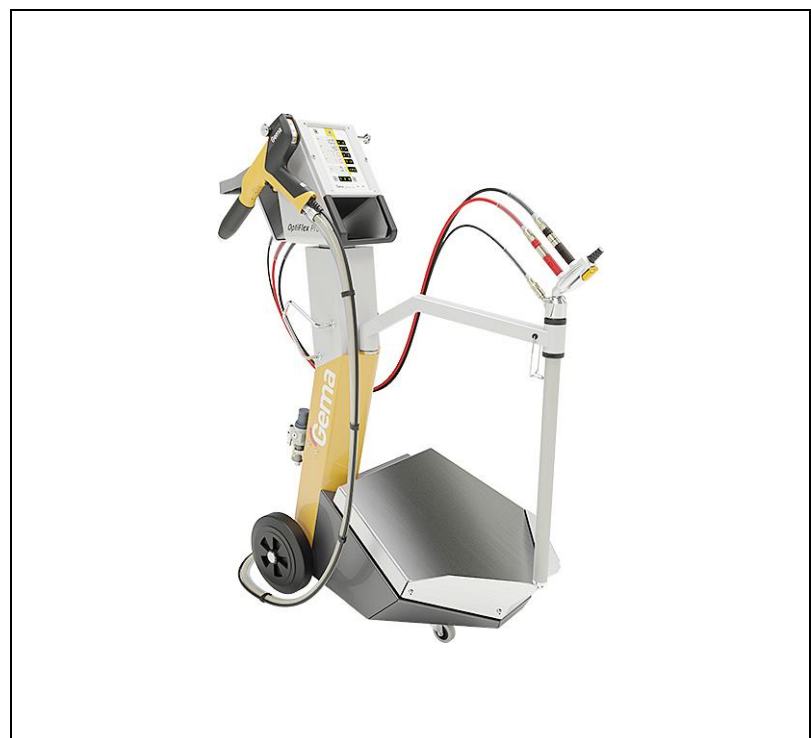

Translation of the original operating instructions

Documentation OptiFlex Pro B

© Copyright 2019 Gema Switzerland GmbH

All rights reserved.

This publication is protected by copyright. Unauthorized copying is prohibited by law. No part of this publication may be reproduced, photocopied, translated, stored on a retrieval system or transmitted in any form or by any means for any purpose, neither as a whole nor partially, without the express written consent of Gema Switzerland GmbH.

Gema, EquiFlow, MagicCompact, MagicCylinder, OptiCenter, OptiFlex, OptiGun, OptiSelect and OptiStar are registered trademarks of Gema Switzerland GmbH.

ClassicLine, ClassicStandard, ClassicOpen, DVC (Digital Valve Control), GemaConnect, MagicControl, MagicPlus, MonoCyclone, MRS, MultiColor, MultiStar, OptiAir, OptiControl, OptiColor, OptiFeed, OptiFlow, OptiHopper, OptiMove, OptiSieve, OptiSpeeder, OptiSpray, PCC (Precise Charge Control), RobotGun, SIT (Smart Inline Technology) and SuperCorona are trademarks of Gema Switzerland GmbH.

All other product names are trademarks or registered trademarks of their respective holders.

Reference is made in this manual to different trademarks or registered trademarks. Such references do not mean that the manufacturers concerned approve of or are bound in any form by this manual. We have endeavored to retain the preferred spelling of the trademarks, and registered trademarks of the copyright holders.

To the best of our knowledge and belief, the information contained in this publication was correct and valid on the date of publication. Gema Switzerland GmbH makes no representations or warranties with respect to the contents or use of this publication, and reserves the right to revise this publication and make changes to its content without prior notice.

For the latest information about Gema products, visit www.gemapowdercoating.com.

For patent information, see www.gemapowdercoating.com/patents or www.gemapowdercoating.us/patents.

Printed in Switzerland

Gema Switzerland GmbH
Mövenstrasse 17
9015 St.Gallen
Switzerland

Phone: +41-71-313 83 00

Fax.: +41-71-313 83 83

E-mail: info@gema.eu.com

Table of contents

About these instructions	7
General information	7
Keeping the Manual	7
Safety symbols (pictograms).....	7
Structure of Safety Notes.....	8
Presentation of the contents	8
Figure references in the text	8
Safety	9
General information	9
Basic safety instructions	9
Product specific security regulations	10
Product description	15
Intended use	15
Reasonably foreseeable misuse.....	16
Structure.....	16
Overall view.....	16
Scope of delivery	17
Typical characteristics – properties of the functions	17
Processing the powder directly from the original powder manufacturer's container	17
Freely rotating head piece	17
PowerClean™ module – Option	17
Technical Data	19
Connectable guns	19
Electrical data	19
Pneumatic data	19
Dimensions	20
Processible powders.....	20
Powder output (reference values).....	20
Air flow rates	21
Environmental conditions.....	21
Sound pressure level	22
Rating plate.....	22
Assembly / Connection	23
Set-up.....	23
Assembly guide.....	23
Connection instructions.....	24
Set head piece	25
Start-up	27
Preparation for start-up	27
Basic conditions	27
Initial start-up.....	28
Setting the device type.....	28

Operation	29
Operation	29
Select predefined operating mode (Preset mode)	30
Starting the individual adjustable programs	30
Setting powder output and powder cloud	31
Setting the electrode rinsing air	32
Rinsing mode	33
Activating the rinsing function	33
Setting the background illumination	36
Color change	37
General information	37
Decommissioning / Storage	39
Decommissioning	39
If in disuse for several days	39
Storage conditions	39
Hazard notes	39
Type of storage	39
Storage duration	39
Space requirements	39
Physical requirements	40
Maintenance during storage	40
Maintenance schedule	40
Maintenance works	40
Maintenance / Repairs	41
General information	41
Interval	41
Daily maintenance	41
Weekly maintenance	41
If in disuse for several days	42
Gun maintenance	42
Maintenance of the filter unit	42
Cleaning	43
Gun cleaning	43
Cleaning the fluidizing/suction unit	44
Repair work	44
Periodic checks	44
Fault clearance	45
Disposal	47
Introduction	47
Requirements on personnel carrying out the work	47
Disposal regulations	47
Materials	47
Spare parts list	49
Ordering spare parts	49
OptiFlex Pro B – Spare parts list	50
OptiFlex Pro B – Spare parts	51
Fluidizing/suction unit	52
Fluidizing/suction tube – spare parts	53
Pneumatic group	54
PowerClean module set**	55

About these instructions

General information

This operating manual contains all important information which you require for the working with the OptiFlex Pro B. It will safely guide you through the start-up process and give you references and tips for the optimal use when working with your powder coating system.

Information about the functional mode of the individual system components should be referenced in the respective enclosed documents.



This operating manual describes all options and functions of this manual coating equipment.

- Please note that your manual coating equipment may not be equipped with all described functions.
- Options are marked by double asterisks**.

Keeping the Manual

Please keep this Manual ready for later use or if there should be any queries.

Safety symbols (pictograms)

The following warnings with their meanings can be found in the Gema instructions. The general safety precautions must also be followed as well as the regulations in the relevant instructions.

DANGER

Indicates a hazardous situation which, if not avoided, will result in death or serious injury.

WARNING

Indicates a hazardous situation which, if not avoided, could result in death or serious injury.

⚠ CAUTION

Indicates a hazardous situation which, if not avoided, could result in minor or moderate injury.

ATTENTION

Indicates a potentially harmful situation. If not avoided, the equipment or something in its surrounding may be damaged.

ENVIRONMENT

Indicates a potentially harmful situation which, if not avoided, may have harmful consequences for the environment.



MANDATORY NOTE

Information which must be observed.



NOTICE

Useful information, tips, etc.

Structure of Safety Notes

Every note consists of 4 elements:

- Signal word
- Nature and source of the danger
- Possible consequences of the danger
- Prevention of the danger

⚠ SIGNAL WORD

Nature and source of the hazard!

Possible consequences of the danger

- ▶ Prevention of the danger

Presentation of the contents

Figure references in the text

Figure references are used as cross references in the descriptive text.

Example:

"The high voltage (**H**) created in the gun cascade is guided through the center electrode."

Safety

General information

This chapter provides the user and third parties who operate this product with all essential safety regulations, the adherence to which is imperative.

These safety regulations must be read and understood in their entirety before the product is put into operation.

The standards and guidelines applied during the development, manufacture and configuration are described in the EC declaration of conformity and in the manufacturer's declaration.

WARNING

Working without instructions

Working without instructions or with individual pages from the instructions may result in damage to property and personal injury if relevant safety information is not observed.

- ▶ Before working with the device, organize the required documents and read the section "Safety regulations".
 - ▶ Work should only be carried out in accordance with the instructions of the relevant documents.
 - ▶ Always work with the complete original document.
-

Basic safety instructions

- This product is built to the latest specification and conforms to the recognized technical safety regulations and is designed for the normal application of powder coating.
- Any other use is considered non-compliant. The manufacturer shall not be liable for damage resulting from such use; the user bears sole responsibility for such actions. If this product is to be used for other purposes or other substances outside of our guidelines then Gema Switzerland GmbH should be consulted.
- Start-up (i.e. the execution of intended operational tasks) is forbidden until it has been established that this product has been set up and wired according to the guidelines for machinery. The standard "Machine safety" must also be observed.
- Unauthorized modifications to the product exempt the manufacturer from any liability from resulting damage.

- The relevant accident prevention regulations, as well as other generally recognized safety regulations, occupational health and structural regulations are to be observed.
- Furthermore, the country-specific safety regulations also must be observed.

Product specific security regulations

- This product is a constituent part of the equipment and is therefore integrated in the system's safety concept.
- If it is to be used in a manner outside the scope of the safety concept, then corresponding measures must be taken.
- The installation work to be done by the customer must be carried out according to local regulations.
- It must be ensured, that all components are earthed according to the local regulations before start-up.



For further security information, see the more detailed Gema safety regulations!

WARNING

These general safety regulations must be read and understood in all cases prior to start-up!



General information

This product is built to the latest specification and conforms to the recognized technical safety regulations and is designed for the normal application of powder coating.

Any other use is considered non-compliant. The manufacturer shall not be liable for damage resulting from such use; the user bears sole responsibility for such actions. If this product is to be used for other purposes or other substances outside of our guidelines then Gema Switzerland GmbH should be consulted.

Observance of the operating, service and maintenance instructions specified by the manufacturer is also part of conformity of use.

The relevant accident prevention regulations, as well as other generally recognized safety regulations, occupational health and structural regulations are to be observed.

Furthermore, the country-specific safety regulations also must be observed.

Additional safety and operation notices can be found on the accompanying CD or on the homepage www.gemapowdercoating.com.



General dangers

Start-up is forbidden until it has been established that the product has been set up and wired according to the EU guidelines for machinery.

Unauthorized modifications to the product exempt the manufacturer from any liability from resulting damages or accidents.

The operator must ensure that all users do have the appropriate training for powder spraying equipment and are aware of the possible sources of danger.

Any operating method, which will negatively influence the technical safety of the powder spraying equipment, is to be avoided.

For your own safety, only use accessories and attachments listed in the operating instructions. The use of other parts can lead to risk of injury. Only original Gema spare parts should be used!

Repairs must only be carried out by specialists or by authorized Gema service centers. Unauthorized conversions and modifications can lead to injuries and damage to the equipment and invalidate the Gema Switzerland GmbH guarantee.



Electrical danger

The connecting cables between the control unit and the spray gun must be installed in such a way, that they cannot be damaged during the operation. Please observe the local safety regulations!

The plug connections between the powder spraying equipment and the mains should only be removed when the power supply is switched off.

All maintenance activities must take place when the powder spraying equipment is switched off.

The product may not be switched on until the booth is in operation. If the booth stops, the product must switch off too.



Explosion hazard

The control units for the spray guns must be installed and used in zone 22. Spray guns are allowed in zone 21.

Only original Gema OEM parts are guaranteed to maintain the explosion protection rating. If damages occur by using spare parts from other manufacturers, the warranty or compensation claim is void!

Conditions leading to dangerous levels of dust concentration in the powder spraying booths or in the powder spraying areas must be avoided. There must be sufficient technical ventilation available, to prevent a dust concentration of more than 50% of the lower explosion limit (UEG = max. permissible powder/air concentration). If the UEG is not known, then a value of 10 g/m³ should be considered (see EN 50177).

All unauthorized conversions and modifications to the electrostatic spraying equipment are forbidden for safety reasons.

No safety devices should be dismantled or put out of operation.

Mandatory operational and workplace notices from the operating company must be written in a comprehensible manner in the language of equipment operators and posted in a suitable place.



Slip hazard

Powder lying on the floor around the powder spraying equipment is a potentially dangerous source of slipping. Booths may be entered only in the places suitable for it.

Static charges

Static charges can have the following consequences: Charges to people, electric shocks, sparking. Proper grounding must be in place to prevent objects from becoming charged.

Grounding

Observe the grounding regulations



All electrically conductive parts found in the workplace of 5 meters around each booth opening, and particularly the objects to be coated, have to be grounded. The grounding resistance of each object must amount to maximally 1 MOhm. This resistance must be checked/tested regularly when starting work.

The condition of the work piece attachments, as well as the hangers, must guarantee that the work pieces remain grounded. The appropriate measuring devices must be kept ready in the workplace, in order to check the grounding.

The floor of the coating area must conduct electricity (normal concrete is generally conductive).

The supplied grounding cable (green/yellow) must be connected to the grounding screw of the electrostatic manual powder coating equipment. The grounding cable must have a good metallic connection with the coating booth, the recovery unit and the conveyor chain, respectively with the suspension arrangement of the objects.

Fire and smoke prohibition



Smoking and open flames

Smoking and igniting fire are forbidden in the entire vicinity of the system! No work that could potentially produce sparks is allowed!

The stay for persons with cardiac pacemakers is forbidden



Stay for persons with cardiac pacemakers

As a general rule for all powder spraying installations, persons with pacemakers should never enter high voltage areas or areas with electromagnetic fields. Persons with pacemakers should not enter areas with powder spraying installations!

Photographing with flashlight is forbidden



Photographing with flashlight

Photographing with flashlight can lead to unnecessary releases and/or disconnections by safety devices.

Disconnect from mains before maintenance works take place



Maintenance works

Disconnect the plugs before the machines are opened for maintenance or repair.

The plug connections between the powder spraying equipment and the mains should only be removed when the power supply is switched off.



As far as it is necessary, the operating firm must ensure that the operating personnel wear protective clothing (e.g. facemasks).

A dust mask corresponding to filter class FFP2 or N95 at minimum must be worn during any cleaning work.

The operating personnel must wear electrically conductive, steel-toe footwear (e.g. leather soles).

The operating personnel should hold the gun with bare hands. If gloves are worn, these must also conduct electricity.

Product description

Intended use

This Manual coating equipment is for use with organic powders coating electrostatically grounded objects.



Fig. 1

Observance of the operating, service and maintenance instructions specified by the manufacturer is also part of conformity of use. This product should only be used, maintained and started up by trained personnel, who are informed about and are familiar with the possible hazards involved.

Any other use is considered non-compliant. The manufacturer is not responsible for any incorrect use and the risks associated with such actions are assumed by the user alone!

Reasonably foreseeable misuse

- Operation without the proper training
- Use with insufficient compressed air quality and grounding
- Use in connection with unauthorized coating devices or components

Structure

Overall view

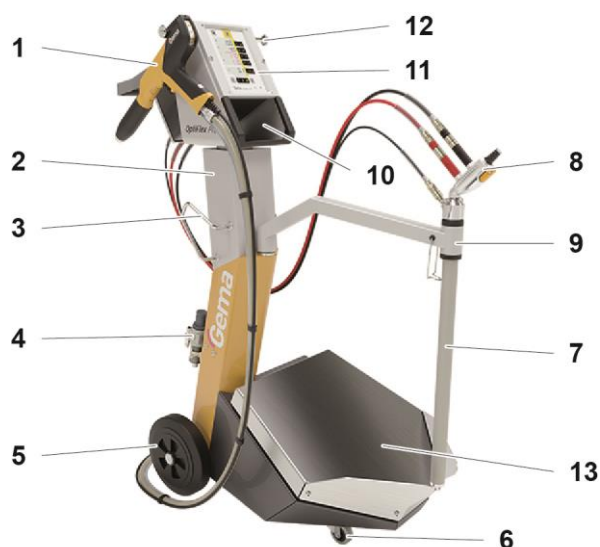

fig. 2

- | | | | |
|---|---------------------------------------|----|--------------------------------|
| 1 | OptiSelect Pro GM04 manual powder gun | 8 | OptiFlow injector |
| 2 | Frame | 9 | Swivel arm with guide sleeve |
| 3 | Hose holder | 10 | Shelf |
| 4 | Filter unit | 11 | OptiStar CG21 Gun control unit |
| 5 | Rubber wheel | 12 | Gun holder |
| 6 | Swivel wheel | 13 | Vibrating table |
| 7 | Fluidizing/suction unit | | |

OptiSelect Pro GM04 manual powder gun

All information about the OptiSelect Pro GM04 manual powder gun can be found in the documentation for that equipment (enclosed with this manual)!

OptiStar 4.0 Gun control unit

All information about the OptiStar 4.0 (Type CG21) manual gun control unit can be found in the documentation for that equipment (enclosed with this manual)!

OptiFlow injector

All information about the OptiFlow injector will be found in the corresponding enclosed documentation!

Scope of delivery

- OptiSelect Pro GM04 manual powder gun with gun cable, powder hose, rinsing air hose and standard nozzle set (For more on this, see the operating manual for the OptiSelect Pro GM04 manual powder gun)
- OptiStar 4.0 Control unit in a metal case with power supply cable
- plug-in OptiFlow injector
- mobile trolley with a gun/hose support
- vibrating base and a fluidizing/suction unit
- PowerClean module**
- Pneumatic hoses for conveying air (red), supplementary air (black), fluidizing air (black) and rinsing air** (black)
- Operating manual
- Short description

Typical characteristics – properties of the functions

Processing the powder directly from the original powder manufacturer's container

The type B manual coating equipment allows for powder to be processed directly out of the original powder manufacturer's container. A tilted vibrating floor has been included to ensure that the powder container empties itself completely.

Freely rotating head piece

The manual coating equipment features a rotating and lockable head piece for more ergonomic operation and configuration (in steps of 45°)



fig. 3

PowerClean™ module – Option

Field of application

The PowerClean module can be used in combination with the OptiStar control unit.

The PowerClean module provides increased stability in application processes. It prevents the bridging phenomena that can lead to short circuiting when handling powders such as metallic powders.

In moist or tropical environments, any moisture is driven from the injector, powder hose and powder gun. The color change is also accelerated during non-extreme color switches.



fig. 4

Technical Data

Connectable guns

OptiFlex Pro B	connectable
OptiSelect Pro Type GM04	yes
OptiSelect type GM03	yes*
TriboJet	yes**

* The PowderBoost functionality is not available

** The gun type must be configured (refer to chapter "Additional functions"). The Tribo gun the gun is not type approved (ATEX).

WARNING

The gun control unit may only be used with the specified gun types!

Electrical data

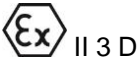
OptiFlex Pro B	
Nominal input voltage	100-240* VAC
Frequency	50-60 Hz
Fluctuations of the power supply	± 10 %
Overtoltage category	OVC II
Connected load	140 VA
Nominal output voltage (to the gun)	12 V
Nominal output current (to the gun)	1.2 A
Connection and output for vibrator (on Aux output)	100-240* VAC max. 100 W
Connection for rinsing function (valve)	24 VDC max. 3 W
Protection type	IP54
Approvals	 

* preset country-specific voltage

Pneumatic data

OptiFlex Pro B	
Compressed air connection	8 mm
Max. input pressure	5.5 bar / 80 psi
Max. water vapor content of the compressed air	1.3 g/m ³
Max. oil vapor content of the compressed air	0.1 mg/m ³

Dimensions

OptiFlex Pro B	
Width	481 mm
Depth	822 mm
Height	1109 mm
Weight	ca. 43 kg

Processible powders

OptiFlex Pro B	
Plastic powder	yes
Metallic powder	yes
Enamel powder	no



Powder output (reference values)

General conditions for the OptiFlow Injector

Powder type	Epoxy/polyester
Powder hose Ø (mm)	11
Type of powder hose	POE with guide strips
Input pressure (bar)	5.5
Correction value C0	Powder output zeroing adjustment

Guide values for OptiStar with OptiFlow Injector

All values in these tables are guide values for new nozzle inserts. Differing environmental conditions, wear and different powder types can affect the table values.

Hose internal diameter (mm)	Ø 11						
Hose length (m)	6		12		18		
Total air volume  (Nm ³ /h)	3.5	5.5	3.5	5.5	3.5	5.5	
Powder output (g/min)							
Powder output  (%)	20	90	105	65	75	45	60
	40	170	205	135	150	100	120
	60	235	280	185	215	145	170
	80	290	350	235	270	185	220
	100	340	405	280	320	220	260

Air flow rates

The total air consists of conveying air and supplementary air, in relation to the selected powder quantity (in %). As a result the total air volume is maintained constant.

OptiFlex Pro B	Range	Factory setting
Flow rate – fluidizing air:		
– Device type B	0-1.0 Nm ³ /h	0.1 Nm ³ /h
– Device type F (without AirMover air requirements)	0-5.0 Nm ³ /h	1.0 Nm ³ /h
– Device type S (with optional fluid plate)	0-1.0 Nm ³ /h	0.1 Nm ³ /h
Electrode rinsing air flow rate	0-5.0 Nm ³ /h	0.1 Nm ³ /h
Flow rate total air (at 5.5 bar)	5 Nm ³ /h	
– Conveying air flow rate	0-5.5 Nm ³ /h	
– Supplementary air flow rate	0-5.5 Nm ³ /h	



The max. total air consumption during the coating operation is < 5,5 Nm³/h:

- Total air = 5 Nm³/h (conveying air + supplementary air)
- Electrode rinsing air = 0,1 Nm³/h (flat jet nozzle)



The total air consumption for the device is determined based on the 3 configured air values (without AirMover air value for device type F).

- These values apply for an internal control pressure of 5.5 bar!

Environmental conditions

OptiFlex Pro B	
Utilization	in the interior
Height	up to 2 000 m
Temperature range	+5 °C - +40 °C (+41 °F - +104 °F)
Max. surface temperature	+85 °C (+185 °F)
Maximum relative humidity	80 % for temperatures to 31 °C, linearly decreasing to 50 % relative humidity at 40 °C
Environment	not for wet environment
Degree of pollution of the intended environment	2 (in accordance with DIN EN 61010-1)

Sound pressure level

OptiFlex Pro B	
Normal operation	< 60 dB(A)

The sound pressure level was measured while the unit was in operation; measurements were taken at the most frequent operator positions and at a height of 1.7 m from the ground.

The specified value is applicable only for this product itself and does not take into account external noise sources or cleaning impulses.

The sound pressure level may vary, depending on the product configuration and space constraints.

Rating plate

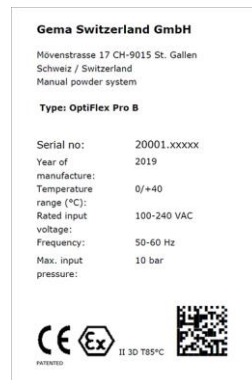

fig. 5

Assembly / Connection

Set-up

The manual coating equipment should always be set up vertically on a flat surface.

WARNING:

Surrounding temperature too high

- ▶ Install the equipment only in locations with an ambient temperature of between +5 and +40 °C, i.e. never next to heat sources (such as an enameling furnace) or electromagnetic sources (such as a control cabinet).

Assembly guide

The manual coating equipment must be set up in accordance with the setup and connecting instructions (included with delivery).



fig. 6



Connection instructions

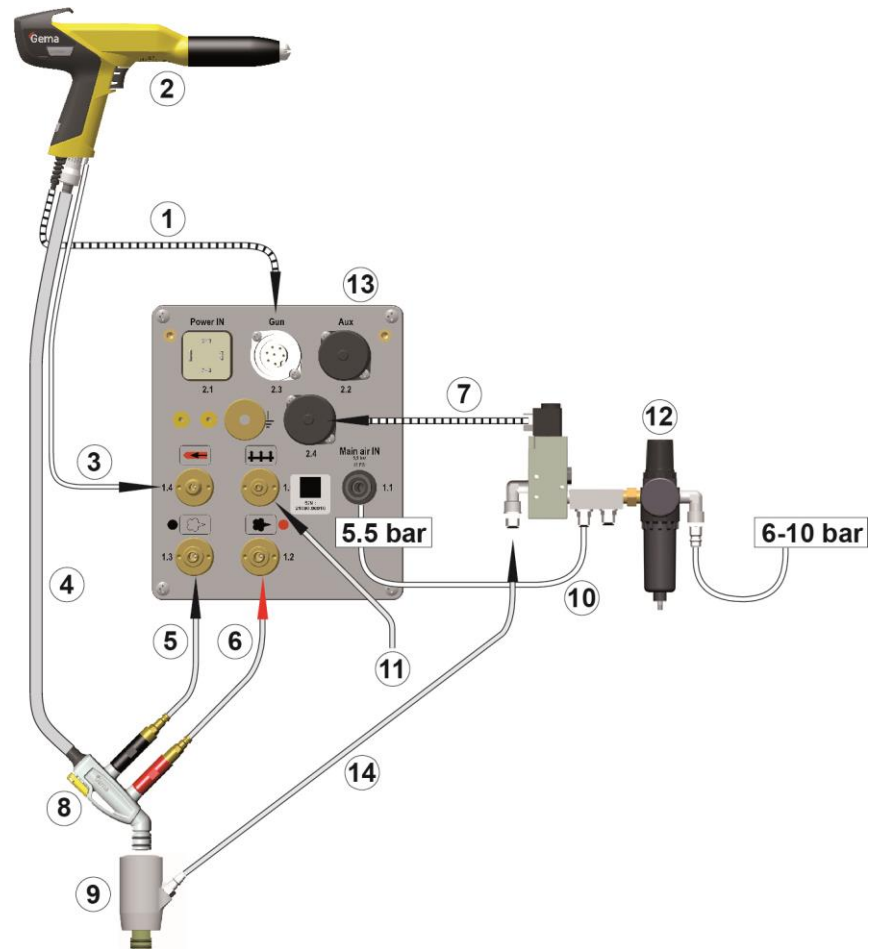

fig. 7: Connecting guide – overview

- | | |
|------------------------------|-------------------------------|
| 1 Gun cable | 8 Injector |
| 2 Manual gun | 9 PowerClean™ module (Option) |
| 3 Electrode rinsing air hose | 10 Compressed air hose |
| 4 Powder hose | 11 Fluidizing air hose |
| 5 Supplementary air hose | 12 Maintenance unit |
| 6 Conveying air hose | 13 OptiStar Control unit |
| 7 Control signal cable | 14 Rinsing air hose |



Use clamp to connect grounding cable to the cabin or the suspension arrangement.

- Check ground connections with Ohm meter and ensure 1 MOhm or less.



The compressed air must be free of oil and water!



Close the unused connections with the provided dust protection caps!

Set head piece

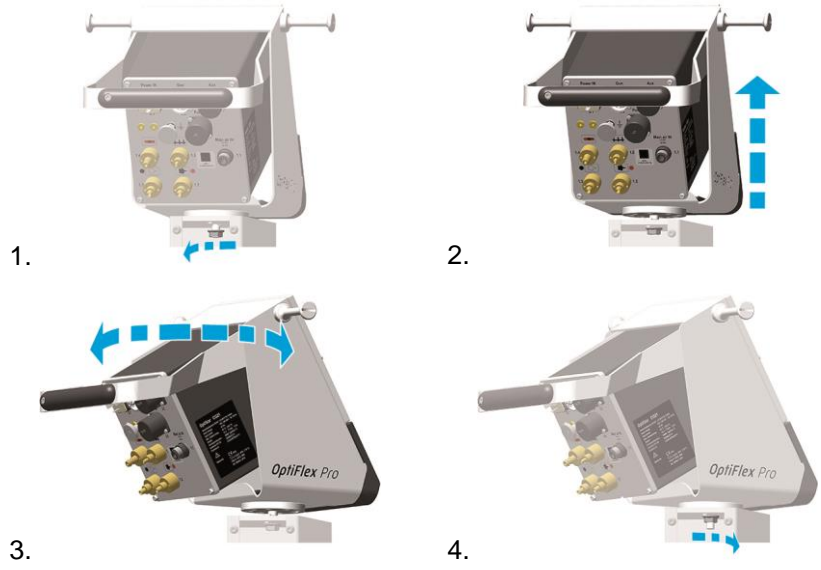

Start-up

Preparation for start-up

Basic conditions

When starting up the gun control unit, the following general conditions impacting the coating results must be taken into consideration:

- Gun correctly connected
- Gun control unit correctly connected
- Corresponding power and compressed air supply available
- Powder preparation and powder quality OK

Initial start-up



If a malfunction occurs, see the troubleshooting guide, as well as the gun control unit operating manual!

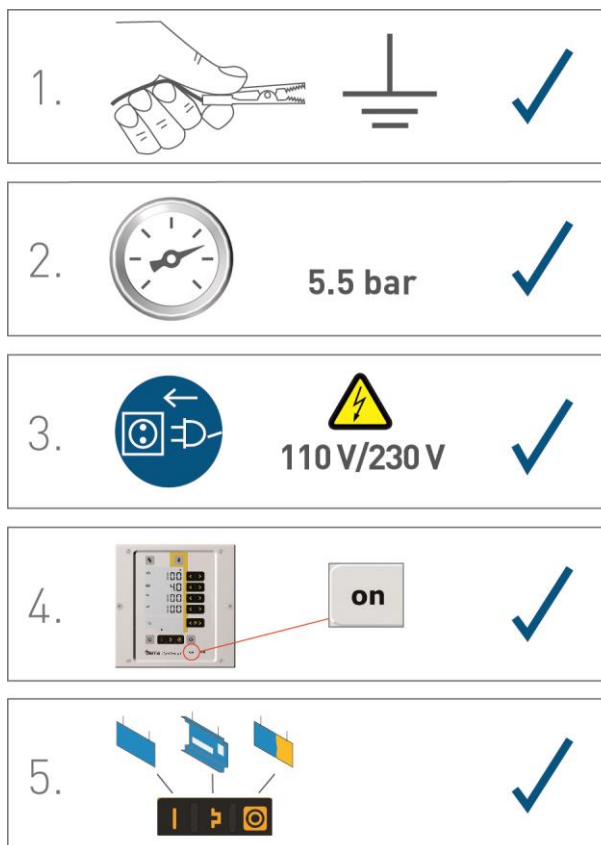

fig. 8



The remainder of the start-up procedure for the gun is explicitly described in the operating instructions for the OptiStar CGxx manual powder gun control unit (chapter "Initial start-up" and "Daily start-up")!

Setting the device type



If the control unit is supplied as a component of a manual coating unit, then the corresponding system parameter is set correctly by the factory!

WARNING:

A wrong parameterization leads to various malfunctions!

- ▶ For more on this, please also see the operating instructions for the OptiStar CGxx gun control unit!

Operation

WARNING

Holding the gun incorrectly

During the coating process, the gun can discharge along the body of the coater if not held using its intended handle, which has been grounded.

- ▶ Always hold gun only by the handle!
- ▶ Do not touch any other parts of the gun!

Operation

CAUTION

Large dust formation possible!

If the manual equipment is not being used for coating in conjunction with a sufficiently powerful suction unit, then the stirred-up dust from the coating powder can cause respiratory issues or cause a slippage/falling hazard.

- ▶ The manual equipment may only be operated in conjunction with a sufficiently powerful suction unit (such as Gema Classic Open booth).

1. Swivel aside the fluidizing/suction unit
2. Place the open powder container on the vibrating table

CAUTION

Hand injury!

When placing a container on the vibrating plate, fingers caught in the gap between the two plates can be crushed.

- ▶ The container may weight a max. of 30 kg.

3. Place the fluidizing/suction unit onto the powder
4. Set coating parameters

Select predefined operating mode (Preset mode)

1. Turn on the gun control unit with the **ON** key
2. Press the corresponding application key.
The arrow above the desired button lights up.

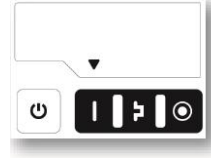

The pre-defined application modes have preset values for high voltage and spray current:

Application mode		Preset μA	Preset kV
	flat parts	100	100
	complicated parts	22	100
	overcoat	10	100

3. The air values for total air, powder output and electrode rinsing air can be individually defined and are saved in the programs.

Starting the individual adjustable programs

1. Turn on the gun control unit with the **ON** key
2. Press the **< P >** program key
3. Select the desired program (01-20)



Program 20 active

4. Change the coating parameters as required



Programs 01-20 are preset at the factory but can be modified at any time, after which they are automatically stored.

Description	Presetting
Powder output	60 %
Total air	4.0 Nm ³ /h
kV High voltage	80 kV
μA Spray current	20 μA
Electrode rinsing air	0.1 Nm ³ /h
Fluidizing air	1.0 Nm ³ /h (for device type F) 0.1 Nm ³ /h (for device type B and S)

Setting powder output and powder cloud

The powder output depends on the selected powder output (in %), and the powder cloud on the selected total air volume.



As a factory default value, a powder rate of 50% and a total air volume of 4 Nm³/h are recommended.

- If values are entered that the gun control unit cannot implement, then the operator is informed of this by a blinking in the relevant display and a temporary error message!

Setting the total air volume

1.   

Adjust the total air volume on the gun control unit with the **T3/T4** keys

- Adjust the total air volume according to the corresponding coating requests



correct powder cloud

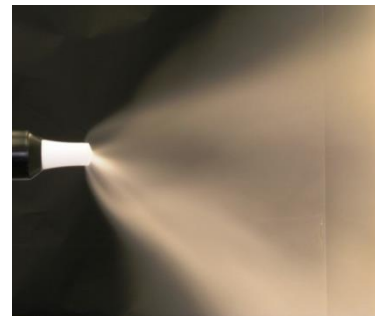

too little total air

Setting the powder output

1.    OR 



much powder



little powder

Adjust the powder output volume (e.g. according to the desired coating thickness)

- Factory default setting of 50% is recommended for initial operation. The total air volume is thereby kept constant automatically by the control unit.



To achieve maximum efficiency, we recommend avoided an overly high powder volume where possible!

2. Check fluidization of the powder in the powder container
3. Point the gun into the booth, switch the gun on and visually check the powder output

Setting the electrode rinsing air

1. Press the  key.
The second display level will be shown.



Adjust the correct electrode rinsing air according to the applied nozzles (deflector plate, flat jet nozzle)

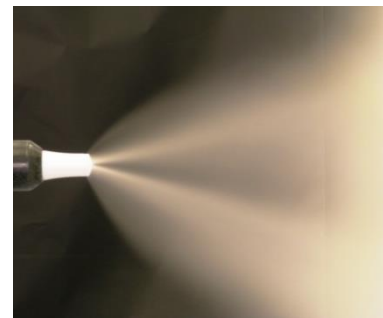
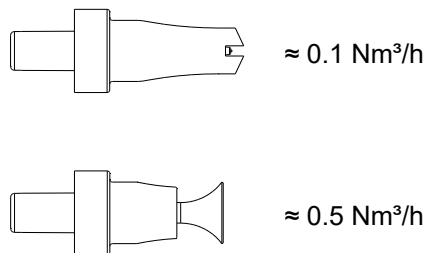

too much electrode rinsing air

3. If in this display level is no operation for 3 seconds, the first display level is switched over independently.

Rinsing mode

The rinsing mode enables blowing off powder accumulations in the powder hose.

Activating the rinsing function

Manual equipment without optional PowerClean module (system parameter P01=0)

The rinsing mode can only be activated from standby mode (main menu display, no powder conveying).



On manual coating equipment type F, the injector must be disconnected prior to cleaning procedure, on type B, the suction unit must be lifted, and on type S, the powder container must be empty.

1. Detach the injector



- 2.

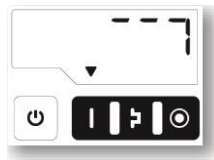

3. **START =**



1 x

= Automatic Procedure



2 x

= Manual Procedure



Procedure	Effect
Automatic (automatic)	<ul style="list-style-type: none"> - The rinsing process is started - Injector, powder hose, gun and spray nozzle are purged using compressed air - The PowerClean function enables parallel cleaning of other components, such as the fluid intake unit, powder container, etc. - The rinsing mode is exited if the automatic rinsing sequence has finished.
Manual (manual)	The operator controls the number and length of the PowerClean impulse by pressing the gun trigger a second time

4. **STOP =**



OR

OR the cleaning mode is terminated automatically.

After completion of the PowerClean procedure, the controller switches back to coating mode.

Manual equipment with optional PowerClean module (system parameter P01= 1 or P01=2)

The rinsing mode can only be activated from standby mode (main menu display, no powder conveying).

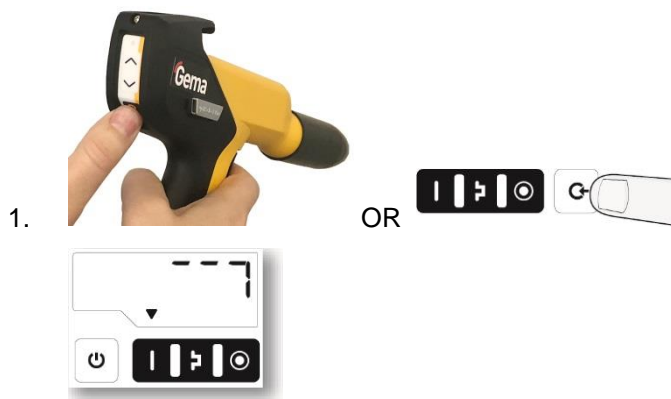

OR

2. **START =**

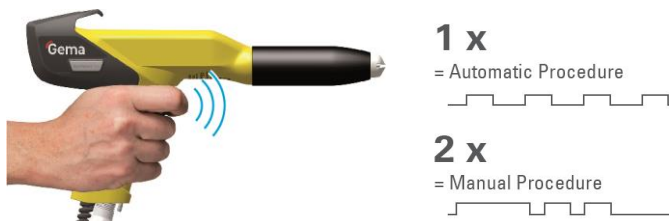

1 x
= Automatic Procedure

2 x
= Manual Procedure

Procedure	Effect
Automatic (automatic)	<ul style="list-style-type: none"> – The rinsing process is started – Injector, powder hose, gun and spray nozzle are purged using compressed air – The PowerClean function enables parallel cleaning of other components, such as the fluid intake unit, powder container, etc. – The rinsing mode is exited if the automatic rinsing sequence has finished.
Manual (manual)	The operator controls the number and length of the PowerClean impulse by pressing the gun trigger a second time

3. STOP =



OR the cleaning mode is terminated automatically.





After completion of the PowerClean procedure, the controller switches back to coating mode.

Setting the background illumination

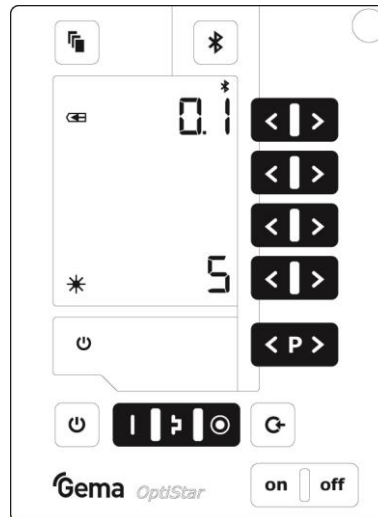
1. Press the  key

The display switches to the following level:



2.    |  |
Select the desired brightness

Color change

General information

When a color change takes place, the individual components of the manual coating equipment must be cleaned carefully. All powder particles of the former color must be removed during this process!

The following describes an 'extreme' color change (light to dark).

1. End the coating procedure
2. Remove the injector from the fluidizing/suction unit
3. The rinsing mode can be activated either on the rear of the powder gun (remote control) or on the control unit
4. Point the gun into the booth
5. Press the gun trigger
 - The rinsing process is started
6. Clean the fluidizing/suction unit with compressed air
7. Clean the powder hose:
 - Disconnect the powder hose from the hose connection on the injector
 - Point the gun into the booth
 - Blow through the hose manually with a compressed air gun
 - Connect the powder hose again to the hose connection on the injector
8. Dismantle and clean the powder gun (see therefore the user manual of the powder gun)
9. Clean the injector (see therefore the injector user manual)
10. Remove the swivel arm and blow off with a compressed air gun
11. Prepare the manual coating equipment with new powder for start-up

Decommissioning / Storage

Decommissioning

1. End the coating procedure
2. Switch off the control unit



The adjustments for high voltage, powder output volume and electrode rinsing air remain stored.

If in disuse for several days

1. Separate from power mains
2. Clean guns, injectors and powder hoses (see therefore the corresponding user manuals)
3. Turn off the compressed air main supply

Storage conditions

Hazard notes

There is no danger to personnel or the environment if the unit is stored properly.

Type of storage

For safety reasons, the product should only be stored in a vertical position.

Storage duration

If the physical conditions are maintained, the unit can be stored indefinitely.

Space requirements

The space requirements correspond to the size of the product.

There are no special requirements concerning distance to neighboring equipment.

Physical requirements

Storage must be inside a dry building at a temperature between +5 and +50 °C. Do not expose to direct sunlight.

Maintenance during storage

Maintenance schedule

No maintenance schedule is necessary.

Maintenance works

During long-term storage, periodically perform a visual check.

Maintenance / Repairs

General information

The product was designed for a maintenance-free operation.

ATTENTION

Any unauthorized modifications and alterations to the product are not permitted for safety reasons and exclude the manufacturer's liability for any resulting damage!



Regular and conscientious cleaning and maintenance increase the service life of the product and ensure consistent high coating quality!

- The parts to be replaced during maintenance work are available as spare parts. These parts can be found in the appropriate spare parts list!

Interval

Daily maintenance

1. Clean the injector (see therefore the user manual of the OptiFlow injector)
2. Clean the powder gun (For more on this, please also review the user manual for the OptiSelect GM03 manual powder gun)
3. Clean the powder hose; Please also review the section "Color change"

Weekly maintenance

1. Clean fluidizing/suction unit, injector, PowerClean** module and powder gun. Place the fluidizing/suction unit back into the powder shortly before restarting operation
2. Check the control unit grounding connections to the coating booth, the suspension devices of the work pieces, or the conveyor chain

If in disuse for several days

1. Separate from power mains
2. Clean the coating equipment
3. Turn off the compressed air main supply

Powder hose rinsing

If longer downtimes take place, the powder hose has to be cleaned.

Procedure:

1. Disconnect the powder hose from the hose connection on the injector
2. Point the gun into the booth
3. Blow through the hose manually with a compressed air gun
4. Connect the powder hose again to the hose connection on the injector

Gun maintenance

The gun is designed to require only a minimum amount of maintenance.

1. Clean the gun with dry cloth, see chapter "Maintenance"
2. Check connection points to powder house.
3. Replace the powder hoses, if necessary.

Maintenance of the filter unit

The filter unit on the manual coating equipment measures and cleans the compressed air. This is where the equipment's main compressed air connection is located.

Replacing the filter element

1. Unscrew the filter glass on the filter unit
2. Remove the complete filter element

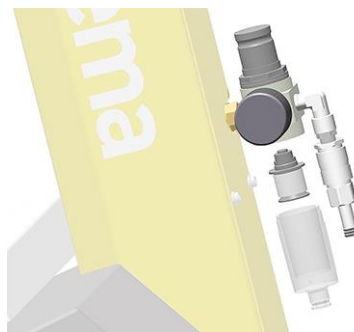

fig. 9

3. Replace the filter element
4. Clean the filter glass on the inside and install it again

Cleaning

CAUTION

Large dust formation possible!

If no dust mask or one of an insufficient filter class is worn when cleaning the product, then the dust that is stirred up from the coating powder can cause respiratory problems.

- ▶ The ventilation system must be turned on for all cleaning work.
- ▶ A dust mask corresponding to filter class FFP2 or N95 at minimum must be worn during any cleaning work.

Gun cleaning

ATTENTION

Impermissible solvents

The following solvents may not be used to clean the gun:

- ▶ Ethylene chloride, acetone, ethyl acetate, methyl ethyl ketone, methylene chloride, premium gasoline, turpentine, tetrachloromethane, toluene, trichloroethylene, xylene!



Only cleaning agents with a flash point of a least 5 Kelvin above the ambient temperature, or cleaning places with technical ventilation are allowed!



Before cleaning the powder gun, switch off the control unit. The compressed air used for cleaning must be free of oil and water!

Daily:

1. Blow off the outside of the gun and wipe, clean etc.

Weekly:

2. Remove powder hose
3. Remove the spray nozzle from the gun and clean it with compressed air
4. Blow through the gun with compressed air, beginning from the connection in flow direction
5. Blow through the gun with compressed air, beginning from the connection in flow direction
6. Clean the integrated gun tube with the brush supplied if necessary
7. Blow through the gun with compressed air again
8. Clean the powder hose
9. Reassemble the gun and connect it

Cleaning the fluidizing/suction unit

ATTENTION

Damage to the fluidizing pads

- ▶ Never clean the fluidizing pads with solvents or water!

1. Remove the injector
2. Remove PowerClean module**
3. Remove the fluidizing/suction unit
4. Clean the fluidizing/suction unit with compressed air. Also blow off the suction tube with compressed air
5. Clean the injector (see therefore the injector user manual)
6. Clean rinsing module**
7. Reassemble the individual parts

Repair work

In the event of malfunctions or faults, the product must be checked and repaired by an authorized Gema service workshop. The repairs must only be performed by an authorized specialist.

Improper tampering can result in serious danger for user and equipment.

Periodic checks

The periodic checks include examining all connecting cables and hoses.

The corresponding parts should be replaced immediately if any damage to cables or hoses is discovered.

All plugs must be properly tightened.

Fault clearance



Prior to any troubleshooting measures, always check whether the equipment parameter (P00) as configured in the control unit is correct

- ▶ See operating instructions for the manual gun control unit, Chapter "Initial Start-up – Setting Equipment Type"!

Incident	Causes	Corrective action
H11 (Help code on control unit)	Gun not connected	Connect the gun
	Gun plug or gun cable defective	Contact local Gema representative
	Remote control on powder gun defective	Contact local Gema representative
Control unit displays remain dark, although the control unit is switched on	Control unit is not connected to the mains	Connect the equipment with the mains cable
	Power pack fuse defective	Replace the fuse
	Power pack defective	Contact local Gema representative
Gun LED remains dark, although the gun is triggered	High voltage adjustment is set too low	Increase high voltage
	Gun plug or gun cable defective	Contact local Gema representative
	LED on gun defective	Contact local Gema representative
Powder does not adhere to object, although the gun is triggered and sprays powder	High voltage and current deactivated	Check the high voltage and current setting
	High voltage cascade defective	Contact local Gema representative
	The objects are not properly grounded	Check the grounding
The gun does not spray powder, although the control unit is switched on and the gun trigger is pressed	Compressed air not present	Connect the equipment to the compressed air
	Injector or nozzle on the injector, powder hose or powder gun clogged	Clean the corresponding part
	Insert sleeve in the injector is clogged	Clean/replace
	Fluidization not running	see below

Incident	Causes	Corrective action
	Pressure valve in the control unit defective	Replace
	Solenoid valve in the control unit defective	Replace
	No conveying air: <ul style="list-style-type: none"> – Throttle motor defective – Solenoid valve defective 	Contact local Gema representative
	Front plate defective	Contact local Gema representative
Gun achieving only poor spray profile	Total air incorrectly configured	Increase the powder quantity and/or total air volume on the control unit
	Bend or damage to air lines to injector	Check air lines to injector
	Insert sleeve in the injector worn or not inserted	Replace or insert it
	Fluidization not running	see below
No electrode rinsing air	Rinsing air throttle motor defective	Contact local Gema representative
The powder is not fluidized	Compressed air not present	Connect the equipment to the compressed air
	Fluidizing air is set too low on the control unit	Set the fluidizing air correctly
	Throttle motor defective	Contact local Gema representative
Vibrator not functioning	Vibrator/condenser broken	Contact local Gema representative
	Vibrator not plugged in	plug in
	Incorrect equipment type configured	Configure parameter P00 (See operating instructions for the manual gun control unit, Chapter "Start-up – Setting Equipment Type")

Disposal

Introduction

Requirements on personnel carrying out the work

The disposal of the product is to be carried out by the owner or operator.

When disposing of components that are not manufactured by Gema, the instructions in the respective manufacturer's documentation must be observed.

Disposal regulations



The product must be disassembled and disposed of properly at the end of its service life.

- ▶ When disposing of the product, the applicable local and regional laws, directives and environmental regulations must be complied with!
-

Materials

The materials must be sorted according to material groups and taken to the appropriate collection points.

Spare parts list

Ordering spare parts

When ordering spare parts for powder coating equipment, please indicate the following specifications:

- Type and serial number of your powder coating equipment
- Order number, quantity and description of each spare part

Example:

- **Type** OptiGun GA03 automatic powder gun
Serial number 1234 5678
- **Order no.** 203 386, 1 piece, Clamp – Ø 18/15 mm

When ordering cable or hose material, the required length must also be given. The spare part numbers of this bulk stock is always marked with an *.

Wearing parts are always marked with a #.

All dimensions of plastic hoses are specified with the external and internal diameter:

Example:

Ø 8/6 mm, 8 mm outside diameter (o/d) / 6 mm inside diameter (i/d)

ATTENTION

Use of non-original Gema spare parts

When using the spare parts from other manufacturers the explosion protection is no longer guaranteed. If any damage is caused by this use all guarantee claims become invalid!

- ▶ Only original Gema spare parts should be used!
-

OptiFlex Pro B – Spare parts list

1	OptiStar CG21 gun control unit – complete (see corresponding operating manual)	
2	OptiSelect Pro GM04 Manual powder gun – complete (see corresponding user manual)	
3	OptiFlow IG07 injector – complete (see corresponding user manual)	
4	Pneumatic connection for supplementary air – complete (incl. Pos. 4.1, 4.2 and 4.3)	1008 029
4.1	Quick release connection – NW5, Ø 8 mm, black	261 637
4.2	Nut with kink protection – M12x1 mm, Ø 8 mm	201 316
4.3	Plastic tube – Ø 8/6 mm, black	1008 038*
5	Pneumatic connection for conveying air – complete (incl. Pos. 5.1, 5.2, 5.3)	1008 030
5.1	Quick release connection – NW5, Ø 8 mm, red	261 645
5.2	Nut with kink protection – M12x1 mm, Ø 8 mm	201 316
5.3	Plastic tube – Ø 8/6 mm, red	103 500*
6	Pneumatic connection for conveying air – complete (incl. Pos. 6.1, 6.2 and 6.3)	1008 031
6.1	Quick release connection – NW5, Ø 6 mm	200 840
6.2	Nut with kink protection – M10x1 mm, Ø 6 mm	201 308
6.3	Plastic tube – Ø 6/4 mm, black	1001 973*
7	Fluidizing/suction unit – complete (see corresponding spare parts list)	1009 679
8	Swivel wheel – Ø 50 mm	260 606
9	Rubber damper – Ø 20x25 mm, M6/2 mm	246 000
10	Spacing ring	375 624
11	Vibrator – 220–240 V, 50 Hz, 1.6 m	1008 919
	Vibrator – 110 V, 50 Hz, 1.6 m	1008 920
	Vibrator – 120 V, 60 Hz, 1.6 m	1008 921
12	Rubber wheel – Ø 200 mm	260 592
13	Hose clamp – Ø 15-18 mm	203 386
14	Quick release connection – NW7.8 – Ø 10 mm	239 267
15	Pneumatic group – complete (see corresponding spare parts list)	
16	Hose holder – right	1017 842
	Hose holder – left	1017 843
17	Grounding cable – complete	301 140
18	Power cable – country-specific	
20	Powder hose – Ø 15/10 mm, 6 m	1001 673*#
21	Spare parts kit – consisting of:	
	Cartridge – complete (1x)	1016 561
	O-ring – Ø 16x2 mm (2x)	1007 794
	Multi-Tool for OptiFlow IG07 (1x)	1017 201
	Cable tie (6x)	200 719
22	Short instructions (not shown)	1017 907
23	Operating instructions (not shown)	1017 931

* Please indicate length

Wearing part

OptiFlex Pro B – Spare parts

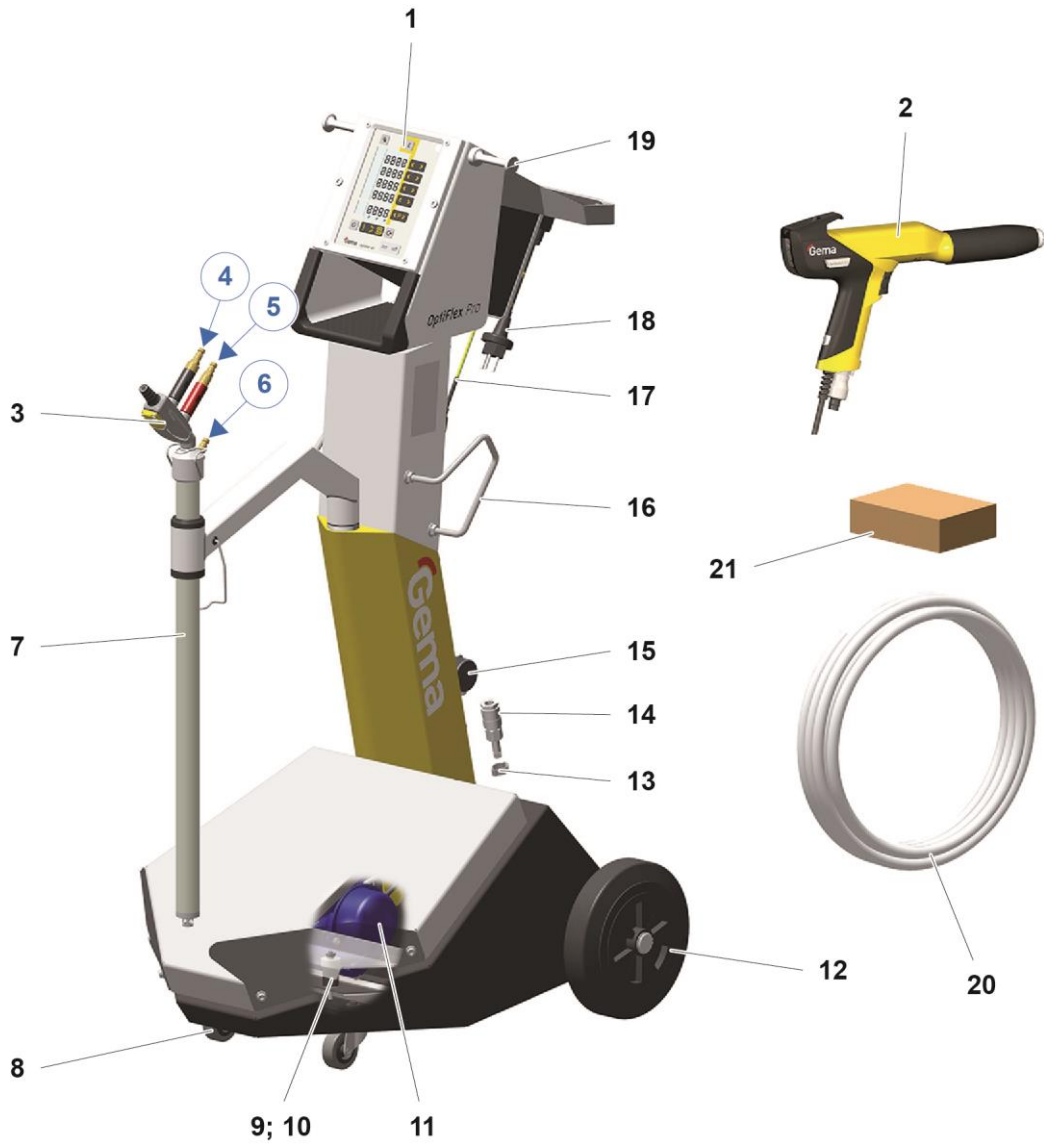

fig. 10:

Fluidizing/suction unit

	Fluidizing/suction unit – complete (pos. 1-10)	1009 679
2	Retaining bracket	1009 524
3	O-ring – Ø 15x1.5 mm	261 564#
4	O-ring – Ø 26x2 mm	246 549#
5	O-ring – Ø 27x3 mm	1007 121#
6	Internal tube	1007 516#
7	O-ring – Ø 24x2 mm	230 480#
8	Fluidizing ring	1007 514#
9	Foot piece	1007 511
10	Connector with flow restrictor – Ø 0.3 mm	1006 556
11	Guide sleeve	1007 094
12	Locknut – M36x1.5 mm	1007 095
13	Retaining bracket	1008 083
14	Cable bush – Ø 4/8/1.5 mm	265 276
15	Bearing bush	1017 813
16	O-ring – Ø 20x2 mm	1017 809#
A	Pneumatic connection for fluidizing air – complete (not shown):	1008 031
	Quick release connection – NW5, Ø 6 mm	200 840
	Nut with kink protection – M10x1 mm, Ø 6 mm	201 308
	Plastic tube – Ø 6/4 mm, black	1001 973

* Please indicate length

Wearing part

Fluidizing/suction tube – spare parts

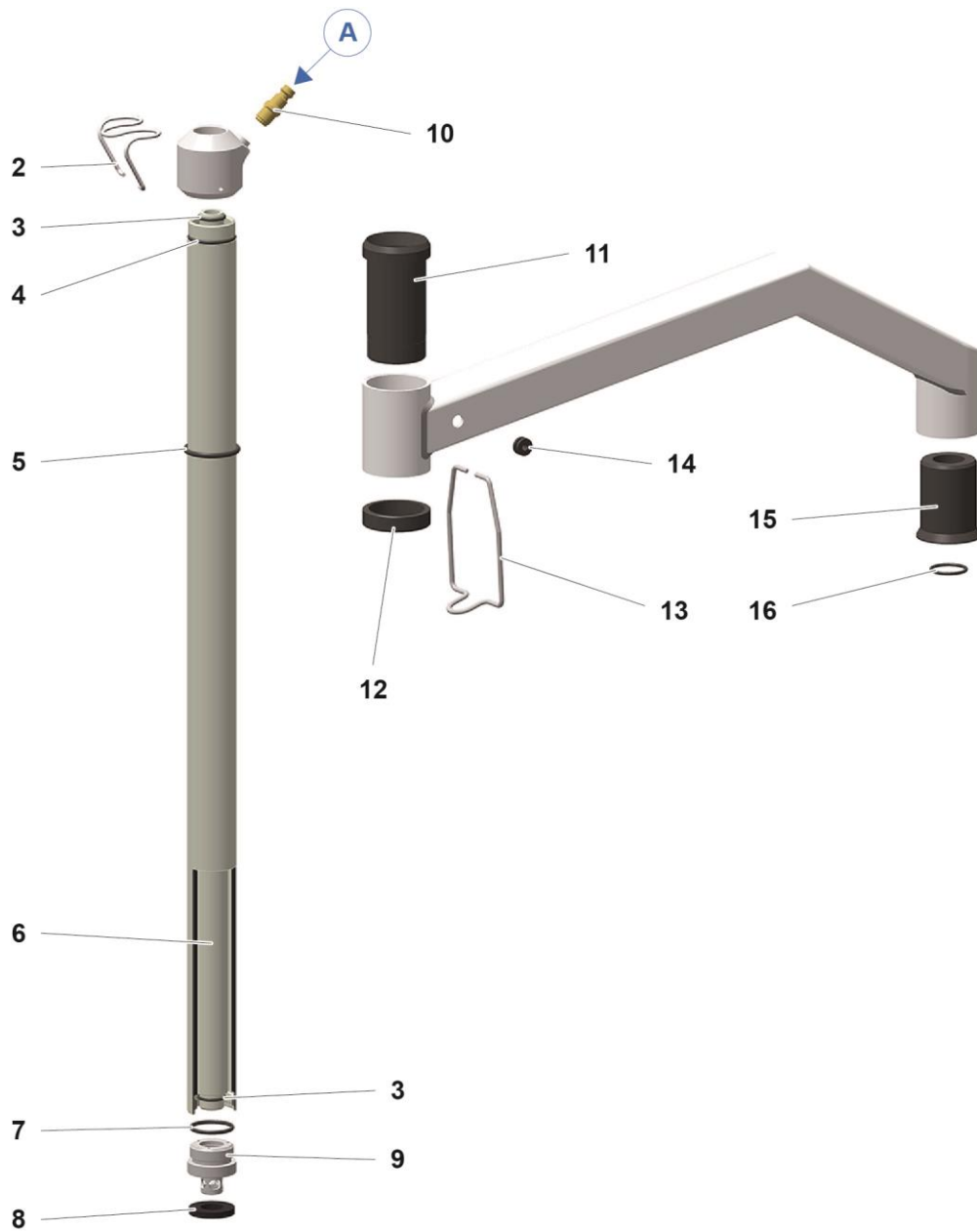

fig. 11: Fluidizing/suction tube – spare parts

Pneumatic group

	Pneumatic group – complete	1017 815
1	Filter cartridge – 20 µm	1008 239#
2	Condensate container with drain valve	1008 238
3	Connector – NW7.4 - 1/4"	256 730
4	Elbow joint – 1/4"-1/4"	222 674
5	Sealing plug – 1/8"	203 297
6	R/F unit – 0-8 bar, 1/4", complete (incl. pos. 1 and 2)	1008 236
7	Double nipple – 1/4"1/4", divisible	261 165
8	Pressure gauge – 0-10 bar, 1/8"	1008 049
9	Distribution block	1017 816
10	Screw-in nipple – 1/4", Ø 8 mm	265 136
11	Plug – Ø 8 mm	238 023

Wearing part

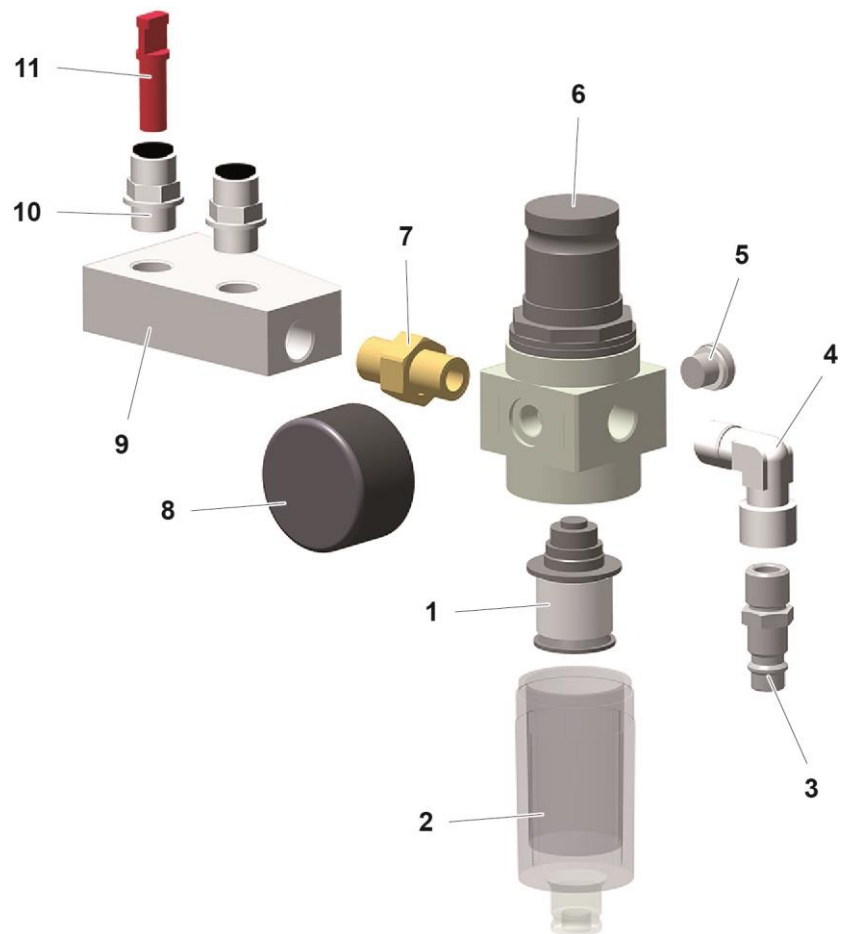

fig. 12: Pneumatic group

PowerClean module set**

	PowerClean module set – rinsing air hose length 2 m (pos. 1, 2, 3, 4 - 7)	1010 519
	PowerClean module set – rinsing air hose length 12 m (pos. 1, 2, 3.1 – 7)	1010 520
1	PowerClean module** – complete (See operating instructions OptiSelect Pro GM04 manual powder gun)	1009 528
2	Solenoid valve – complete	1009 928
3	PowerClean module cable – complete, length 1 m	1009 879
3.1	PowerClean module cable – complete, length 15 m	1009 880
4	Quick release connection – NW5-Ø 8 mm	1008 027
5	Plastic tube – Ø 8/6 mm, black	103 152*
6	O ring – Ø 16x2 mm, NBR70, anti-static (2x) (not shown)	#
7	Cable tie (not shown)	

* Please indicate length

Wearing part

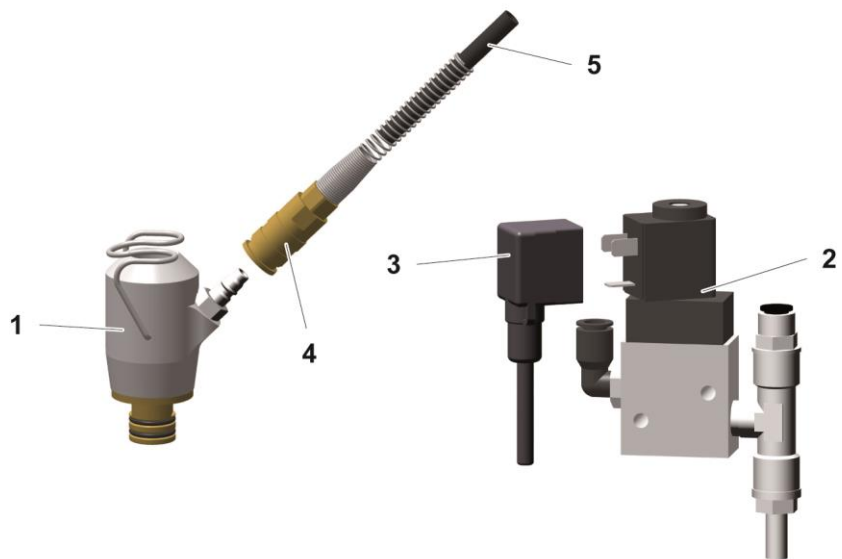

fig. 13: PowerClean module set**

Index

A

About these instructions.....	7
Assembly.....	23

B

Basic safety instructions.....	9
--------------------------------	---

C

Cleaning.....	43
Connectable guns.....	19
Connection.....	23

D

Decommissioning.....	39
Dimensions.....	20
Disposal.....	47
Disposal regulations.....	47
Disuse for several days.....	39

E

Electrical data.....	19
Environmental conditions.....	21

F

Fault clearance.....	45
Figure references in the text.....	8

I

Intended use.....	15
-------------------	----

M

Maintenance.....	41
Maintenance during storage.....	40

O

Operation.....	29
----------------	----

P

Periodic checks.....	44
Pictograms.....	7
Pneumatic data.....	19
Powder output (reference values).....	20
PowerClean™ module.....	17
Presentation of the contents.....	8
Product description.....	15
Product specific security regulations.....	10

R

Rating plate.....	22
Repair work.....	44
Repairs.....	41

S

Safety.....	9
Safety symbols.....	7
Sound pressure level.....	22
Spare parts list.....	49
Start-up.....	27
Storage.....	39

